

# SR160 Surface Roughness Tester

## Instruction Manual

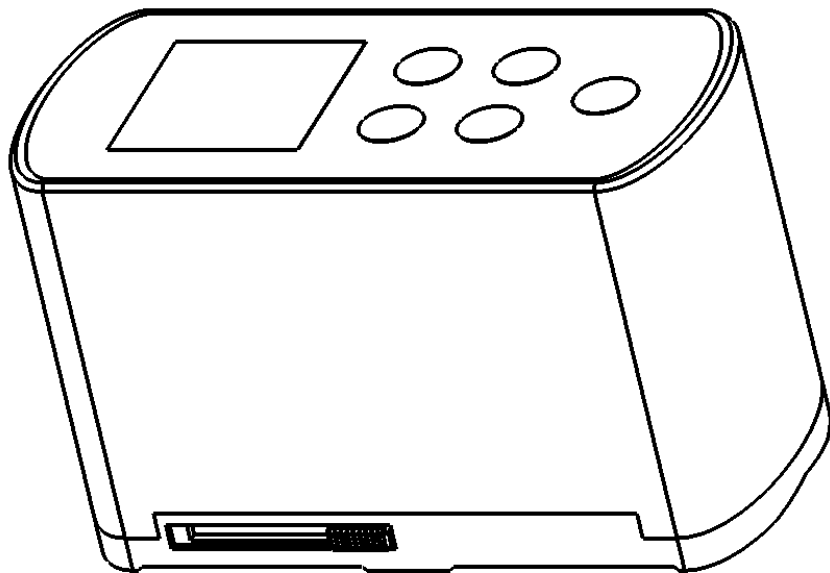

## 目次

1 Brief.....	2
2 Working Theory.....	3
3 Structural Diagram .....	4
4 Specification .....	4
5 Operation .....	5
5.1 Start to test .....	5
5.2 On/ off .....	6
5.3 Test .....	7
5.4 Calibration .....	7
5.5 Choose Specification .....	9
5.6 Choose Standard .....	9
5.7 Choose interface an color .....	10
5.8 Date Calibration .....	10
5.9 Waveform Display.....	10
5.10 Battery Recharge .....	11
6 Maintenance .....	11
6.1 Maintenance .....	11
6.2 Repair .....	12
7 Data Definition.....	12
8 About Users .....	14
9 Sample length Chart .....	15

## 1 Brief Introduction:

SR160 portable roughness tester is a new generation of portable surface roughness tester introduced by our company. It has the characteristics of high measurement accuracy, wide measurement range, simple operation, easy portability and stable operation. It can be widely used in the detection of various metal and non-metal processing surfaces. It is a pocket instrument integrated with the host computer of sensors. It has the characteristics of hand-held, and is more suitable for use in the production site.

## Features:

The exterior is designed by drawing aluminium die, which is durable and has remarkable anti-electromagnetic interference ability, and conforms to the new trend of design today.

High-speed DSP processor is used for data processing and calculation, which greatly improves the speed of measurement and calculation.

Display LCD uses popular LCD display, high brightness, no

angle of view, wide temperature, suitable for various occasions.

Full-band graphical display facilitates operators to view the actual measurement of Parts'surface conditions.

The lithium-ion rechargeable battery can work for a long time without memory effect. It can work while charging, with short charging time and long battery life.

Use universal USB interface to charge and communicate. It is convenient and fast to charge by special charger or USB port of computer.

LCD liquid crystal display, rich information interface prompts.

Real-time monitoring of lithium battery power and display, timely reminding users of charging and charging progress prompt.

The function of automatic shutdown and the design of low power software and hardware make the instrument work too long and suitable for various field use.

The sensor probe has a protective door, which effectively protects the sensor probe and ensures the accuracy of

measurement.

## 2 Working Theory

When the sensor moves along the measured surface at a uniform speed and straight line driven by the driving mechanism, the internal stylus to the working surface displaces vertically with the micro-uneven contour of the working surface, and then transforms the displacement change into the change of the electric quantity through the sensor. The electric signal is amplified, filtered and rotated through A/D. Digital signal is replaced by digital signal, then processed by DSP, Ra, Rz, Rq, Rt values are calculated and displayed.

## 3 Spare Parts drawings

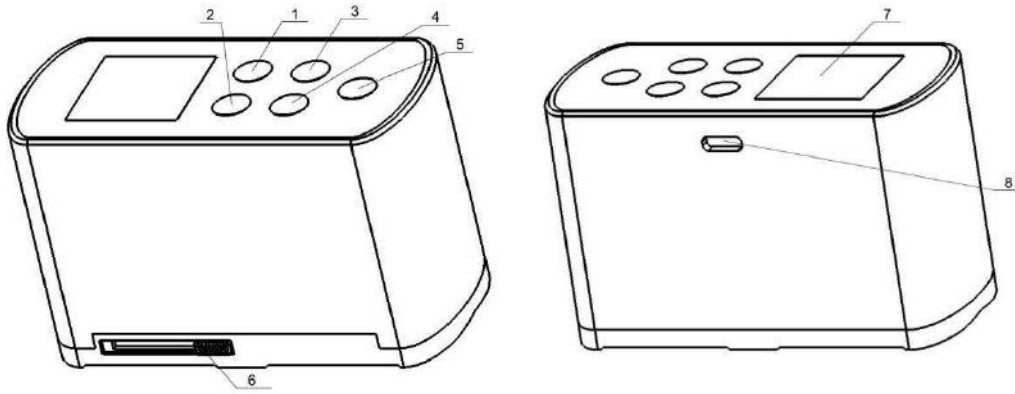

- 1、Tab    2、Info    3、Up    4、Down    5、Measure  
 6、Protection Board Switch    7、Display    8、USB

#### 4. Specifications:

- ◆ Parameter ( $\mu\text{m}$ ) : Ra、Rz、Rq、Rt
- ◆ Travel Length (mm) : 6
- ◆ Sample Length (mm) : 0.25 , 0.80 , 2.50
- ◆ Evaluation Length (mm) : 1.25 , 4.0
- ◆ Measuring Range ( $\mu\text{m}$ ) :
  - Ra、Rq: 0.05 ~ 10.0
  - Rz、Rt: 0.1 ~ 50
- ◆ Display Error :  $\pm 10\%$
- ◆ Display Variability :  $< 12\%$
- ◆ Stylus Radius and Angle:

Stylus Radius :  $10 \mu\text{m} \pm 1 \mu\text{m}$

Angle :  $90^\circ \pm 10^\circ$

◆ 传感器触针静测力及其变化率:

触针静测力:  $\leq 0.016\text{N}$

测力变化率:  $\leq 800\text{N/m}$

◆ Sensor Guide Pressure :  $\leq 0.5\text{N}$

◆ Battery : 3.7V

◆ Size: 90 mm×42 mm×55 mm

◆ Weight: 220g

◆ Working Condition:

Temperature:  $-20^\circ\text{C} \sim 40^\circ\text{C}$

Relative Humidity:  $< 90\%$

No Vibration and Corrosive Medium around

## 5 Operation

### 5.1

Measuring preparation: Remove the instrument, at which time the guard door of the sensor probe should be closed

(see figure below).

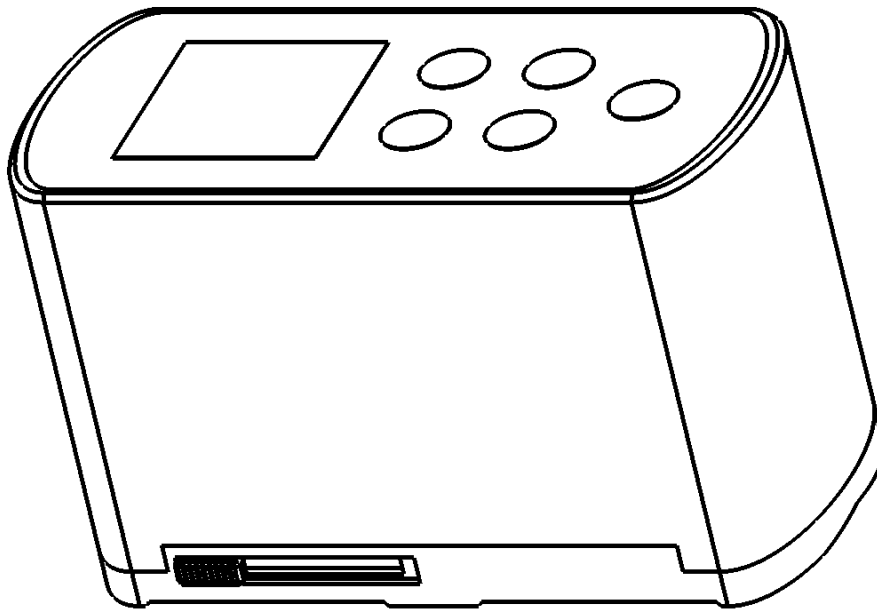

At this time, the 6 warehouse door switch should be pushed right to the probe protection door switch, and the sensor probe protection door should be opened to reveal the sensor probe ready for measurement (see belowing figure).

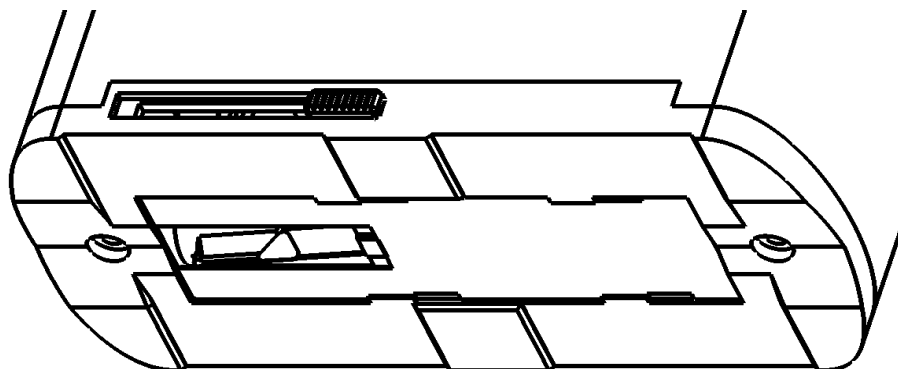



## 5.2 Switch ON/OFF

**Start up:** Press any key for 2 seconds to start up, and then enter the state to be measured. The measurement parameters and sampling length will remain in the state before the last shutdown.

**Shutdown:** In the boot-up state, press button  for 2 seconds, and the instrument enters a low power consumption state. Within 2 minutes, no key operation instrument will automatically shut down.

## 5.3

**Measurement:** After choosing the measurement parameters and sampling length, mark the measuring area indicator of the instrument to the measured area, press the key at the top of the instrument gently after stabilization, move the sensor and start measuring. The liquid crystal display "Measuring" is invalid when pressing other keys. When "Measuring" disappears, the measured value will appear on the screen, but the sensor The device has not been reset. Pressing other keys is invalid at this time. After "beep", the measurement

is finished. At this time, other keys can be operated according to actual needs.



NOTE:

(1) In the process of sensor movement, the instrument should be placed as smoothly as possible to avoid affecting the measuring accuracy of the instrument.

(2) Before the sensor is positioned, the instrument will no longer respond to the measurement operation.



(3) When the instrument crashes, press the measuring key to shut down and restart it to operate.

5.4 Calibration: Before use, the instrument should be calibrated with random standard samples. The nominal value of the standard sample is 2.99 as an example.

Place the instrument in the positioning window of the sample block, measure the state after booting, hold down "   " for 2 seconds, and display as



follows.

Measur ement	
Ra	<b>2.99</b> um
CUTOFF L: 2.50mm	
STANDARD: JIS	
UI COLOR: B-C	
18, Jul 19, 03:27, 87%	





The machine enters the calibration state. Press the  button adjusts the display value to the position that needs to be modified, press the button   to adjust the value , and the sample nominal value is 2.99, as follows

Graph.

Measur ement	Measur ement	Measur ement
Ra <b>2.99</b> um	Ra <b>2.99</b> um	Ra <b>2.99</b> um
CUTOFF L: 2.50mm	CUTOFF L: 2.50mm	CUTOFF L: 2.50mm
STANDARD: JIS	STANDARD: JIS	STANDARD: JIS
UI COLOR: B-C	UI COLOR: B-C	UI COLOR: B-C
18, Jul 19, 03:27, 87%	18, Jul 19, 03:27, 87%	18, Jul 19, 03:27, 87%

After calibrating the measured values, press the   key both at the same time to save the calibration and exit.

If the user has a multi-notched sample block close to the measured value, according to needed testing range to choose the sample block , which will improve the accuracy of measurement significantly.





5.5 Selection of parameters: Users select the required measurement parameters Ra, Rz, Rq, Rt, and press the  key to enter the switching mode until the parameters unit shadow, press the key   a to the choose required Ra, Rz, Rq, Rt values. After confirming, press the  key continuously until it exits the switching mode interface. As shown in the figure:

Measur ement	
Ra	2.99 $\mu\text{m}$
CUTOFF L: 2.50mm	
STANDARD: JIS	
UI COLOR: B-C	
18, Jul 19, 03:27, 87%	

5.6 Selection Standard: Press the **Tab** Key into the switch mode until the switch to the standard unit shadow, and press the **↑** **↓** key to choose the unit  $\mu\text{m}$  (metric) or UIN (British system) needed , and press the **Tab** key continuously until the switch mode interface exits. As shown the figure below

Measur ement	
Ra	2.99 $\mu\text{m}$
CUTOFF L: 2.50mm	
STANDARD: JIS	
UI COLOR: B-C	
18, Jul 19, 03:27, 87%	

Sampling length is 0.25mm, 0.8mm and 2.5mm.

When press the  keys enter the switching mode and switch to the shadows of length unit, and the press the   key to choose the length of measurement needed , finally press the  key to exit the interface of switching mode . As shown in the figure:

Measur ement	
Ra	2.99 $\mu\text{m}$
CUTOFF L:	2.50mm
STANDARD:	JIS
UI COLOR:	B-C
18, Jul 19, 03:27, 87%	

5.7 Select the interface color: the same as the 5.6 operation.

5.8 Time and date calibration: same as 5.6 operation.

Waveform display: When the measurement is

completed, press the **Info** key enters the graphics display interface, and press the **Tab** key enters the position where the switching graphics are located (the measuring graphics of this instrument are divided into four sections), press the **↑** **↓** key enlarging and reducing in proportion to the graphics. Press the **Info** key to exit. As shown in the figure:

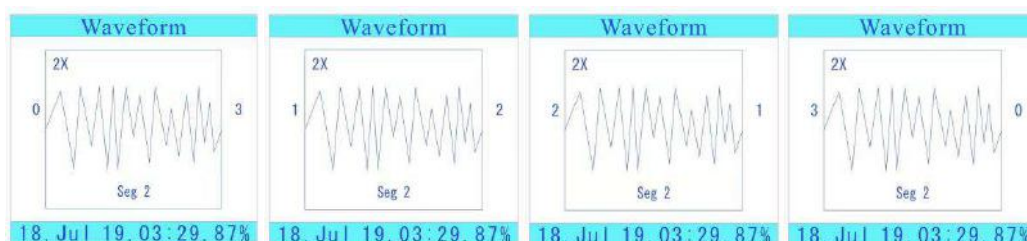

## 5.10 Battery Charge

Insert the charger into the charging hole and charge for 3 hours. When charging, the symbol flickers to show charging animation. Fill up and the animation ends. The charging interface display can be activated even when the power is off.

## 6 Maintenance

## 6.1 Maintenance

◆ Avoid the situation of collision, violent vibration, heavy dust, humidity, oil pollution, strong magnetic field, etc.

◆ After each measurement, the power supply should be switched off in time to maintain the battery energy.

The battery should be charged in time.

◆ Sensors are the precise parts of the instrument. Keep in mind that they are carefully maintained. Each use

After that, cover the protective cover of the instrument gently. Avoid causing damage to sensors

**Violent vibration;**

◆ Random standard samples (calibration block) should be carefully protected from scratches resulting in inaccuracy of calibration instruments.

## 6.2 Repair

If the instrument fails, the manufacturer is responsible for the maintenance. Users are not allowed to disassemble or repair themselves. The



instrument sent back to the manufacturer for repair should be accompanied by a calibration sample randomly equipped with the warranty card, and the phenomenon of failure should be explained.

## 7 Data Definition

The parameter calculation of this instrument conforms to GB/T 3505 "Terminology, Definition and Parameters of Surface Structure Profile Method of Product Geometry Technical Specification".

- ◆ Surface roughness: refers to the micro-geometric characteristics of the machined surface with small spacing and valleys.

- ◆ Sampling length: The length of a reference line used to distinguish the surface roughness characteristics.

- ◆ Evaluation length: The length of a section necessary for assessing contours, which may include one or more sampling lengths.

- ◆ Arithmetic mean deviation of contour Ra:

Arithmetic mean of contour offset in sampling length.

$$Ra = \frac{1}{n} \sum_{i=1}^n |y_i|$$

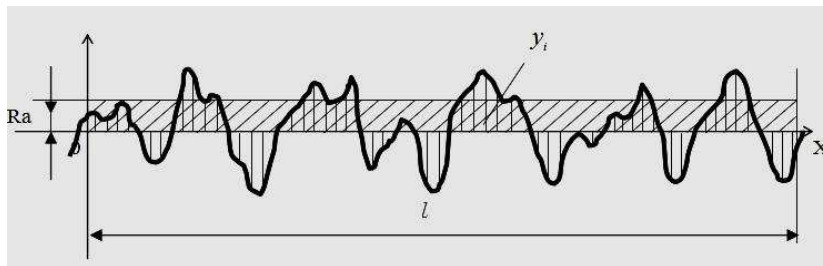

◆ RMS deviation  $Rq$  of contour: RMS value of ordinate values within a sampling length

$$Rq = \left( \frac{1}{n} \sum_{i=1}^n y_i^2 \right)^{\frac{1}{2}}$$

◆ Contour maximum height  $Rz$  (ISO): The height of the sum of maximum contour peak height  $Rp$  and maximum contour Valley depth  $Rv$  within a sampling length.

$$Rz = \frac{\sum_{i=1}^5 y_{pi} - \sum_{i=1}^5 y_{vi}}{5}$$

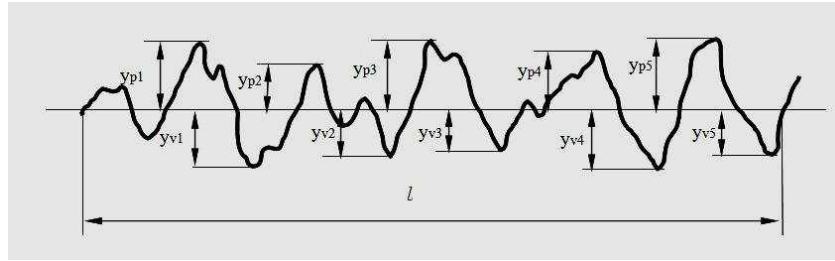

◆ Total height of contour peak and valley  $R_t$ :  
The sum of maximum contour peak height and maximum contour Valley depth in the evaluation length.

◆ Maximum contour peak height  $R_p$ : The distance from the top line of contour peak to the middle line within the sampling length.

◆ Contour maximum Valley depth  $R_v$ : The distance from the bottom to the middle of the contour valley within the sampling length.

## 8 Sales-after service

After purchasing our products, please fill in the Warranty Registration Card carefully, stamp the official seal of the user unit and send the copy of the purchase invoice back to our company, or consign the vending unit to bring it with you when purchasing the machines. If the procedures are incomplete, the maintenance can only be prevented.

The product of our company has quality failure within one year (except for non-warranty parts) from the date of purchase. Please contact our company with the warranty card or copy of purchase invoice. The product can be repaired free of charge. During the warranty period, the warranty card or copy of purchase invoice can not be produced. Our company calculates the warranty period according to the date of leaving the factory for one year.

If the product beyond the warranty period fails, the maintenance fee shall be checked according to the company's regulations.

Where the company's products are disassembled by the user or improperly transported or kept by the user or not

Correct operation in accordance with the "Instructions for the Use of Products" causes damage to the products, and

Privately alter the warranty card, without purchase certificate, the company can not guarantee.

## List of non-guaranteed parts

### Standard Calibration Sample Block for Battery

### Charger of Shell Sensor

## 9 Sample Length Chart

Ra ( $\mu\text{m}$ )	Rz ( $\mu\text{m}$ )	取样长度 (mm)
>40-80	>160-320	8
>20-40	>80-160	
>10-20	>40-80	
>5-10	>20-40	2.5
>2.5-5	>10-20	
>1.25-2.5	>6.3-10	0.8
>0.63-1.25	>3.2-6.3	
>0.32-0.63	>1.6-3.2	
>0.25-0.32	>1.25-1.6	0.25
>0.2-0.25	>1.0-1.25	
>0.16-0.20	>0.8-1.0	
>0.125-0.16	>0.63-0.8	
>0.1-0.125	>0.5-0.63	
>0.08-0.1	>0.4-0.5	0.25
>0.0063-0.08	>0.32-0.4	
>0.05-0.063	>0.25-0.32	
>0.04-0.05	>0.2-0.25	
>0.032-0.04	>0.16-0.2	
>0.025-0.032	>0.125-0.16	
>0.02-0.025	>0.1-0.125	
>0.016-0.02	>0.08-0.1	0.08
>0.0125-0.016	>0.063-0.08	
>0.01-0.0125	>0.05-0.063	
>0.008-0.01	>0.04-0.05	
>0.0063-0.008	>0.032-0.04	
$\leq 0.063$	$\leq 0.032$	

## Packing List

NO.	Items	Qty.
<b>1</b>	Main unit	<b>1</b>
<b>2</b>	Calibration Block	<b>1</b>
<b>3</b>	Charger	<b>1</b>

<b>5</b>	USB cable	<b>1</b>
<b>6</b>	Instruction Manual	<b>1</b>
<b>7</b>	QC certificate	<b>1</b>
<b>8</b>	Guarantee Card	<b>1</b>
<b>9</b>	Suitcase	<b>1</b>